

ASSEMBLY INSTRUCTION  
ASSEMBLERBEFEHL  
INSTRUCTIONS DE MONTAGE

---

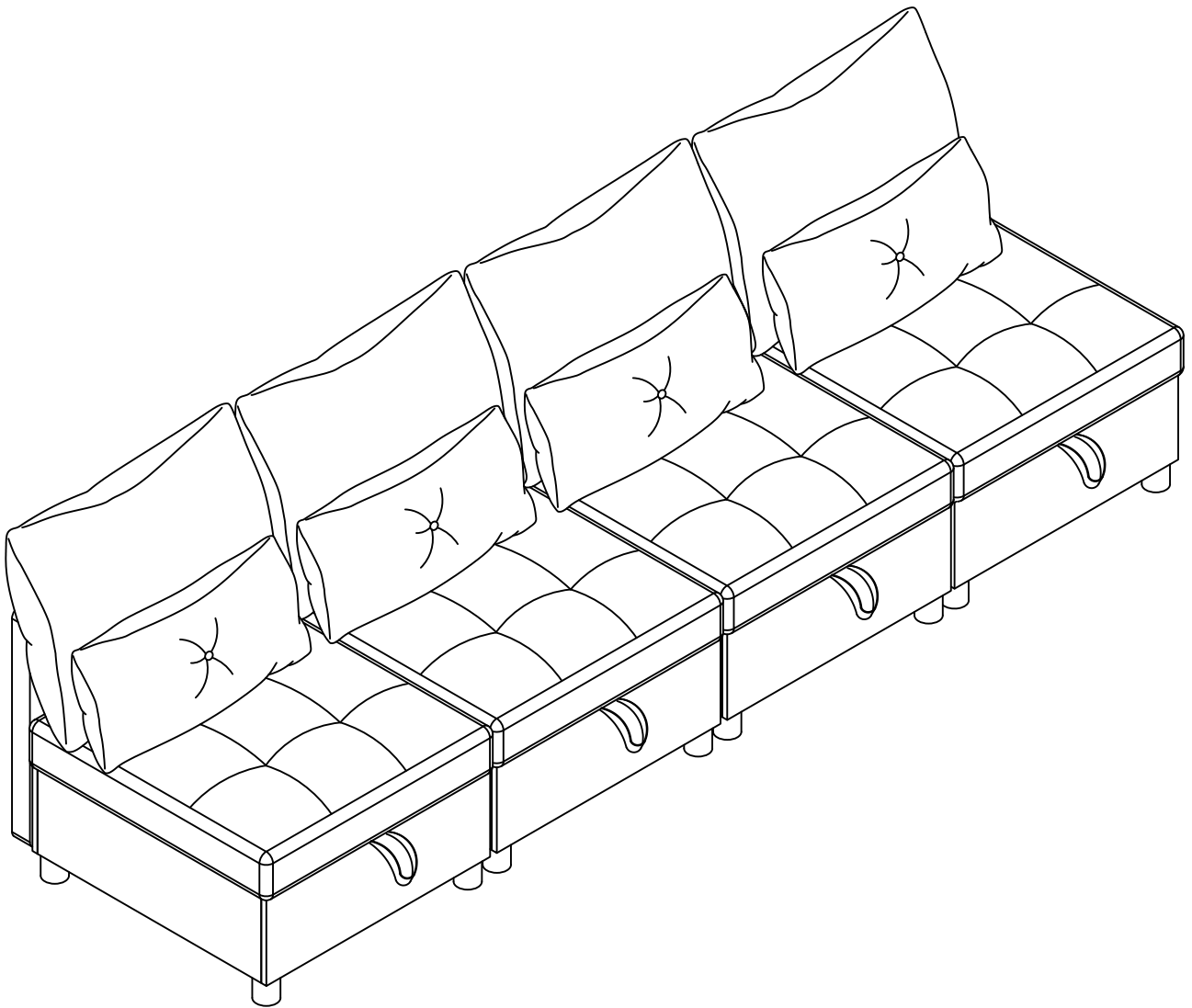

ITEM#N621P334850  
N621P334851  
N621P334852  
N621P334853



<b>Importeur</b>	<b>Decobus Handel GmbH</b>
<b>Adresse</b>	<b>Innungsstraße 9,21244 Buchholz,Deutschland</b>
<b>URL</b>	<b><a href="https://www.decobusgroup.de">https://www.decobusgroup.de</a></b>
<b>Hersteller</b>	<b>XIAMEN TRADE EASY SUPPLYCHAIN CO.,LTD</b>
<b>Adresse</b>	<b>1101-2, TAIWANESE MERCHANT'S BUILDING, XIANYUE ROAD,XIAMEN,CHINA</b>
<b>Email/URL</b>	<b><a href="mailto:sales07@xmprx.com">sales07@xmprx.com</a></b>
<b>Partienummer</b>	<b>N621P334850 / N621P334851 / N621P334852 / N621P334853</b>
<b>Hergestellt in</b>	<b>CHINA</b>
	<b>Decobus Handel GmbH</b> <b>Innungsstraße 9,21244 Buchholz,Deutschland</b> <b><a href="https://www.decobusgroup.de">https://www.decobusgroup.de</a></b>



#### [DE]

Warnung: Lesen Sie die Anleitung vor dem Zusammenbau bitte vollständig durch. Überprüfen Sie, ob Sie alle auf den Seiten aufgeführten Komponenten und Werkzeuge haben.

Warnung: Überprüfen Sie regelmäßig alle Beschläge und Befestigungen, um sicherzustellen, dass sie sicher sind und um Unfälle zu vermeiden.

Warnung: Stellen Sie Möbel nicht in die Nähe von Feuerquellen oder heißen Gegenständen, um Brandgefahr zu vermeiden.

Warnung: Erlauben Sie Kindern nicht, auf die Möbel zu klettern, da dies zum Umkippen und zu schweren Verletzungen führen kann. Bauen Sie die Möbel außerhalb der Reichweite von Kindern zusammen.

#### [EN]

Warning: Please read instructions fully before starting assembly. Check you have all the components and tools listed on pages.

Warning: Regularly check all fittings and fastenings to ensure they are secure and to prevent accidents.

Warning: Do not place furniture close to fire sources or high-temperature objects to avoid the risk of fire.

Warning: Do not allow children to climb on the furniture as this may result in tipping and serious personal injury. Assemble the furniture away from the reach of children.

#### [FR]

Avertissement : Veuillez lire entièrement les instructions avant de commencer l'assemblage. Vérifiez que vous disposez de tous les composants et outils répertoriés sur les pages.

Avertissement : Vérifiez régulièrement tous les accessoires et fixations pour vous assurer qu'ils sont bien fixés et pour éviter les accidents.

Avertissement : Ne placez pas les meubles à proximité de sources de feu ou d'objets à haute température pour éviter tout risque d'incendie.

Avertissement : Ne laissez pas les enfants grimper sur les meubles car cela pourrait entraîner un basculement et des blessures graves. Assemblez les meubles hors de portée des enfants.

#### [IT]

Attenzione: leggere attentamente le istruzioni prima di iniziare il montaggio. Verificare di avere tutti i componenti e gli utensili elencati nelle pagine.

Attenzione: controllare regolarmente tutti i raccordi e gli elementi di fissaggio per assicurarsi che siano sicuri e prevenire incidenti.

Attenzione: non posizionare i mobili vicino a fonti di fuoco o oggetti ad alta temperatura per evitare il rischio di incendio.

Attenzione: non consentire ai bambini di arrampicarsi sui mobili poiché ciò potrebbe causare ribaltamenti e gravi lesioni personali. Montare i mobili lontano dalla portata dei bambini.

#### [ES]

Advertencia: Lea las instrucciones completamente antes de comenzar el montaje. Compruebe que tiene todos los componentes y herramientas que se enumeran en las páginas.

Advertencia: Compruebe periódicamente todos los accesorios y sujeciones para asegurarse de que estén seguros y evitar accidentes.











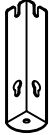
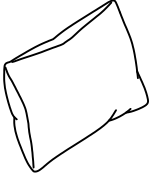

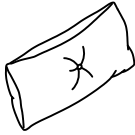
Advertencia: No coloque los muebles cerca de fuentes de fuego u objetos a alta temperatura para evitar el riesgo de incendio.

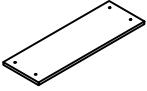
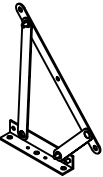
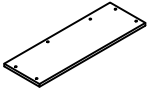
Advertencia: No permita que los niños se suban a los muebles, ya que esto puede provocar que vuelquen y lesiones personales graves. Monte los muebles fuera del alcance de los niños.

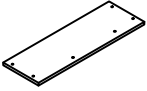
## STÜCKLISTEN KASTEN 1:N621P334850

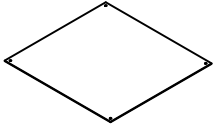
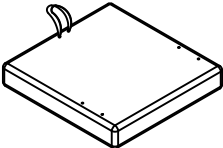
## PART LISTS BOX 1:N621P334850

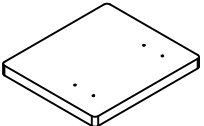
## LISTES DE PIÈCES CASE 1:N621P334850









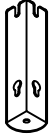
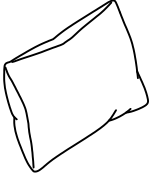

Teile-Nr. Part NO. N° de pièce	TeileImage Part Image Partie Image	QTY QTY QTÉ	Teile-Nr. Part NO. N° de pièce	TeileImage Part Image Partie Image	QTY QTY QTÉ
1		4	9		1
2		4	10		1
3		1	11		2
4		1	12		1
5		1	13		1
6		2	14		1
7		1	15		2
8		1	16		4

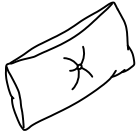
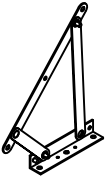
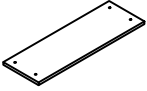
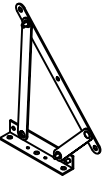
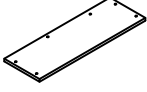

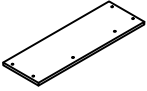
## STÜCKLISTEN KASTEN 2:N621P334851

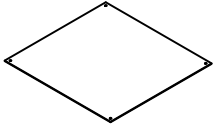
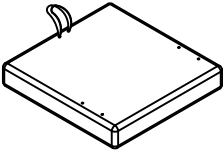

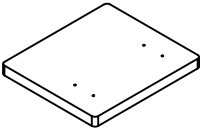





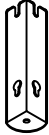
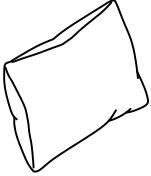

## PART LISTS BOX 2:N621P334851

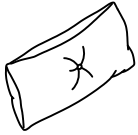
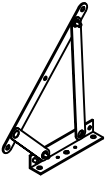
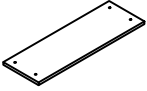
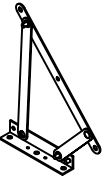
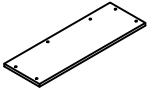
## LISTES DE PIÈCES CASE 2:N621P334851

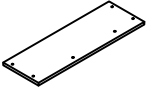
Teile-Nr. Part NO. N° de pièce	TeileImage Part Image Partie Image	QTY QTY QTÉ	Teile-Nr. Part NO. N° de pièce	TeileImage Part Image Partie Image	QTY QTY QTÉ
1		4	9		1
2		4	10		1
3		1	11		2
4		1	12		1
5		1	13		1
6		2	14		1
7		1	15		2
8		1	16		4

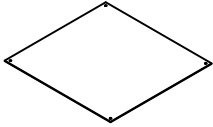
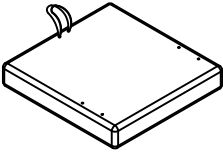

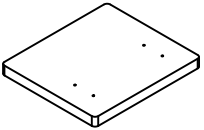
STÜCKLISTEN KASTEN 3:N621P334852  
 PART LISTS BOX 3:N621P334852  
 LISTES DE PIÈCES CASE 3:N621P334852











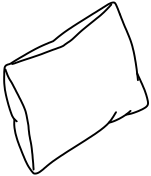

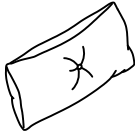
Teile-Nr. Part NO. N° de pièce	TeileImage Part Image Partie Image	QTY QTY QTÉ	Teile-Nr. Part NO. N° de pièce	TeileImage Part Image Partie Image	QTY QTY QTÉ
1		4	9		1
2		4	10		1
3		1	11		2
4		1	12		1
5		1	13		1
6		2	14		1
7		1	15		2
8		1	16		4

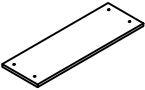
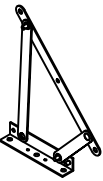
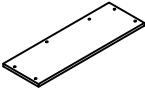

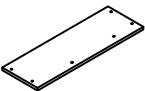
## STÜCKLISTEN KASTEN 4:N621P334853

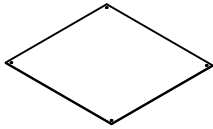
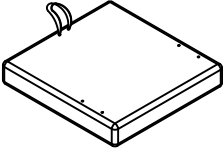
## PART LISTS BOX 4:N621P334853

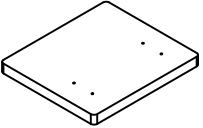
## LISTES DE PIÈCES CASE 4:N621P334853

Teile-Nr. Part NO. N° de pièce	TeileImage Part Image Partie Image	QTY QTY QTÉ	Teile-Nr. Part NO. N° de pièce	TeileImage Part Image Partie Image	QTY QTY QTÉ
1		4	9		1
2		4	10		1
3		1	11		2
4		1	12		1
5		1	13		1
6		2	14		1
7		1	15		2
8		1	16		4





**1** x4

M8\*16 **A** x16

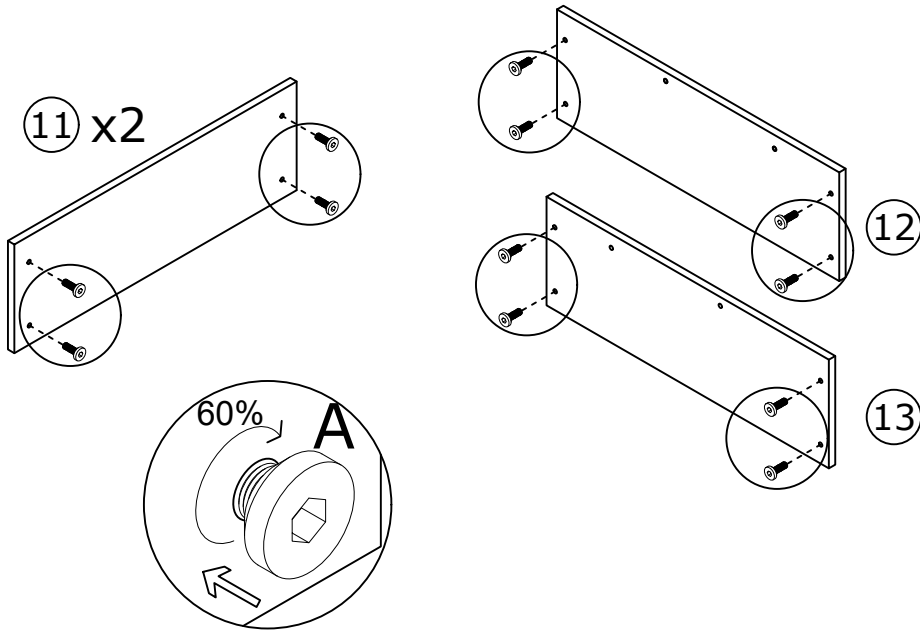

**2** x4

**1** x4

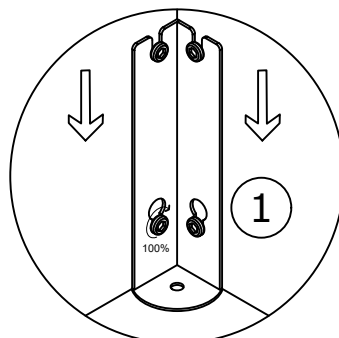
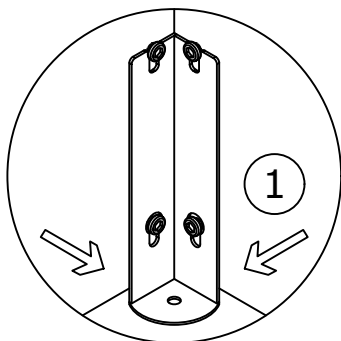
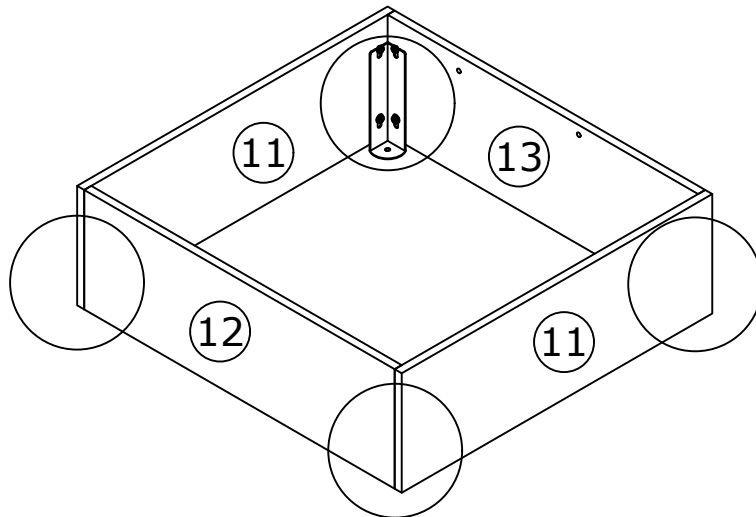

### 3 x4

 2 x4

 16 x4

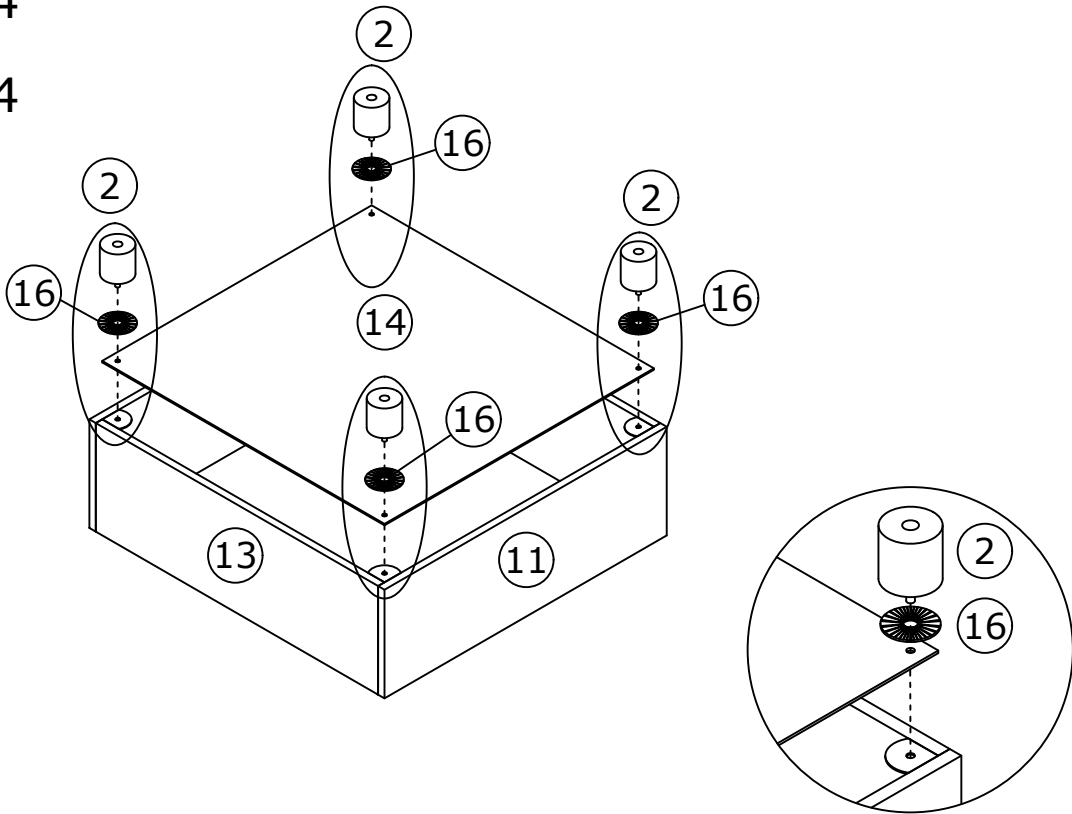

### 4 x4

 M6\*16 B x4

 3 x1

 4 x1

 15 x2

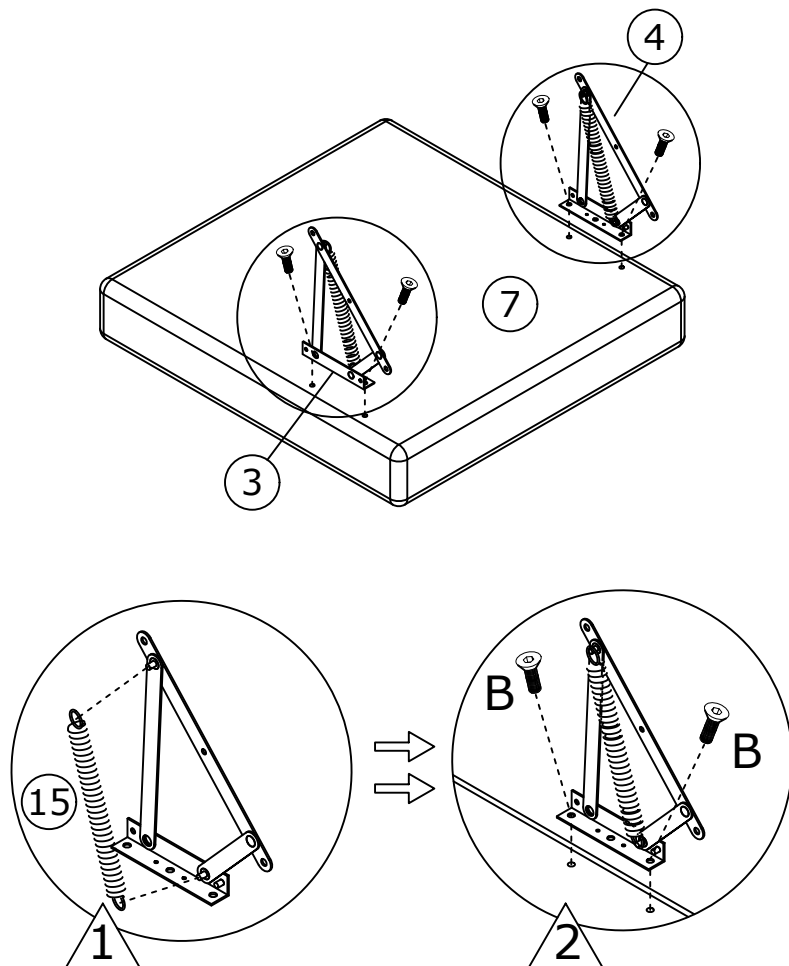

**5** x4

M6\*16 **B** x4

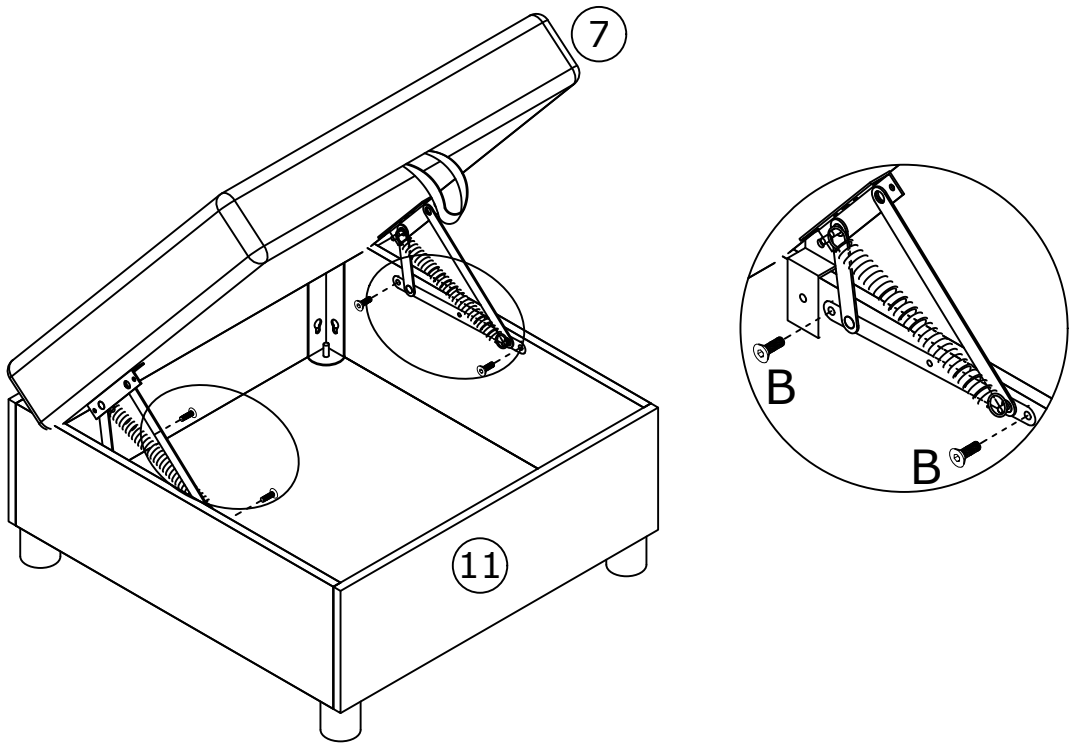

**6** x4

M8\*16 **A** x4

**6** x2

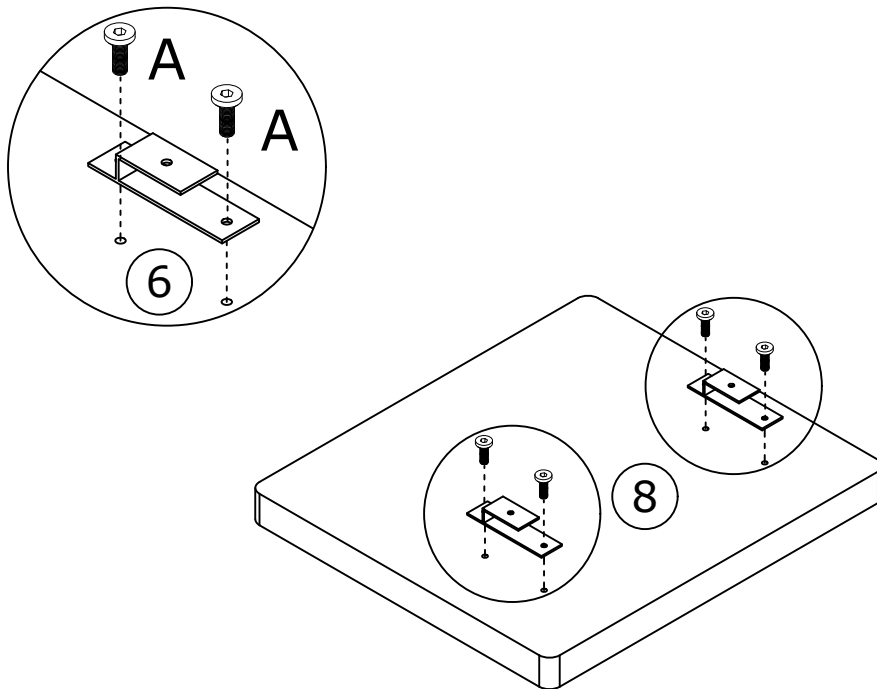

7 x4

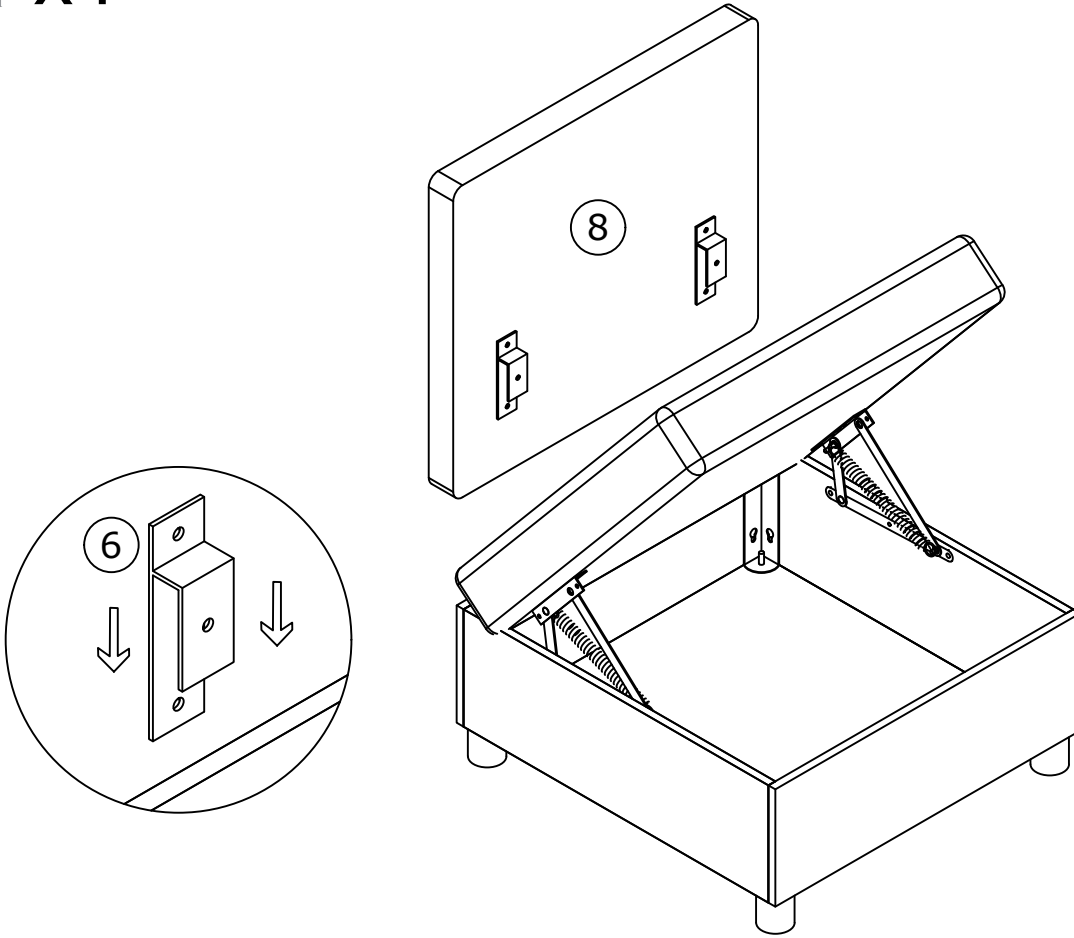

8

 5 x3

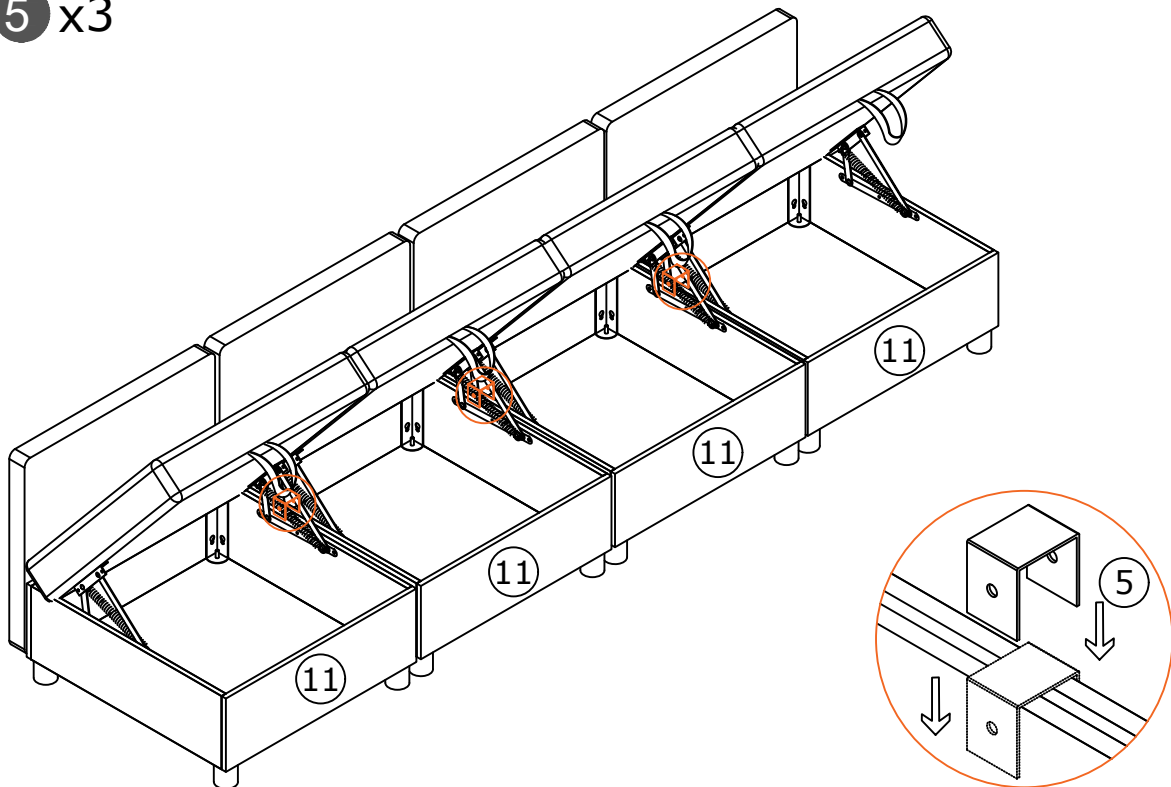

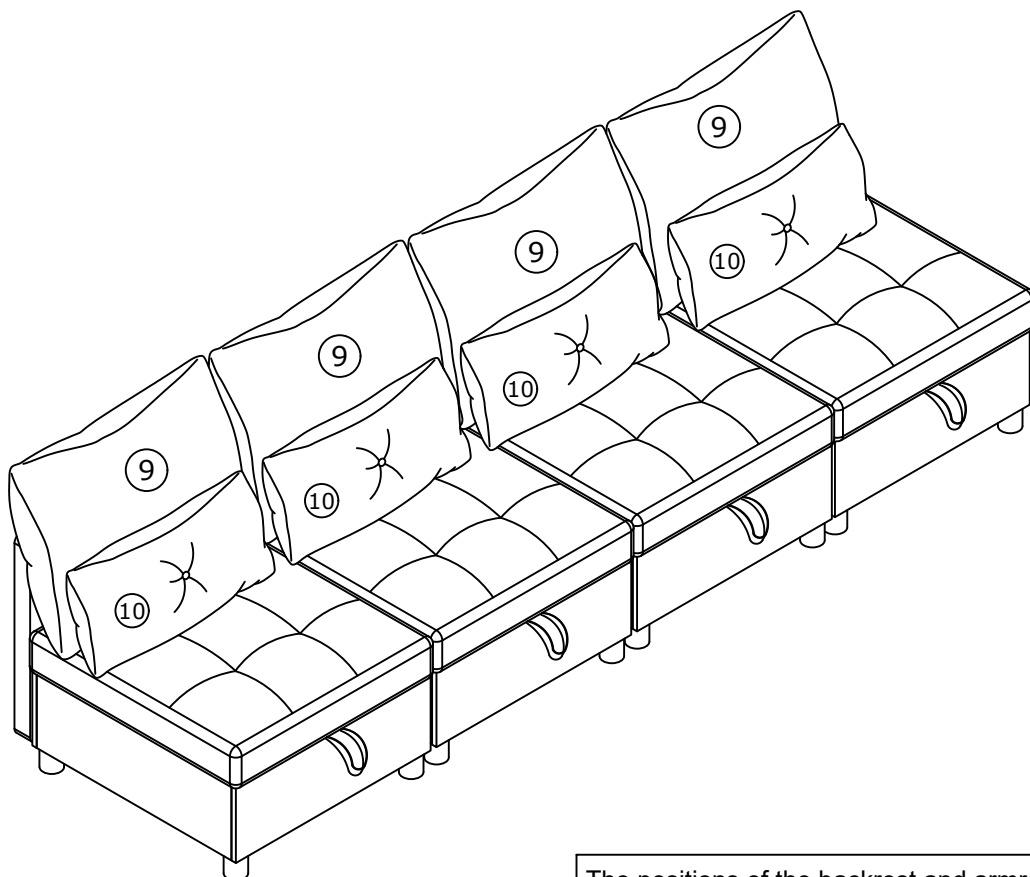

The positions of the backrest and armrest  
can be interchanged as required.  
Die Positionen der Rückenlehne und Armlehne  
können nach Bedarf ausgetauscht werden.  
Les positions du dossier et du repose-pieds  
peuvent être échangées sur demande.

