

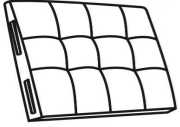

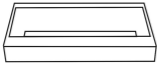

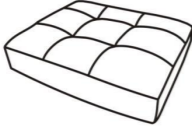

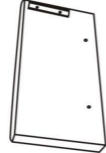

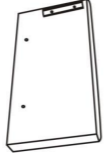

# ASSEMBLY INSTRUCTION

<b>Ax1</b>	<b>Bx1</b>	<b>Cx1</b>	<b>Dx1</b>	<b>Ex1</b>	<b>Fx1</b>	<b>Gx1</b>	<b>H1x4</b>	<b>H2x1</b>	①Washer <b>X4</b>	②Screws (8X60) <b>X4</b>	③Screws (6X20) <b>X8</b>	④Gasket X1	⑤Wrench X1
													
Back Cushion	Seat Frame	Seat Cushion	Left Armrest	Right Armrest	Back Side(L)	Back Side(R)	Legs	Leg (Middle)					

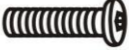
## DIAGRAM 1 (Assemble the Armrest)

Assemble the Left and Right Armrests(Part D and Part E) to the Seat Frame(Part B) with Washers (1)and Screws(2).

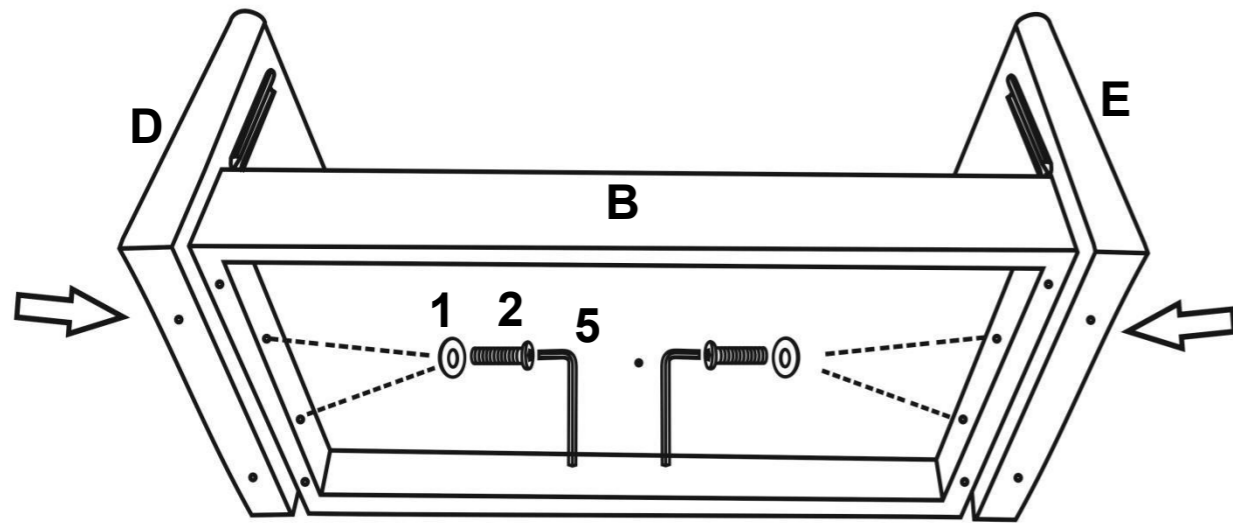

## DIAGRAM 2 (Assemble the Legs)

Assemble the Legs(Part H1 and H2) on the sofa with Screws (3) and Gasket (4).

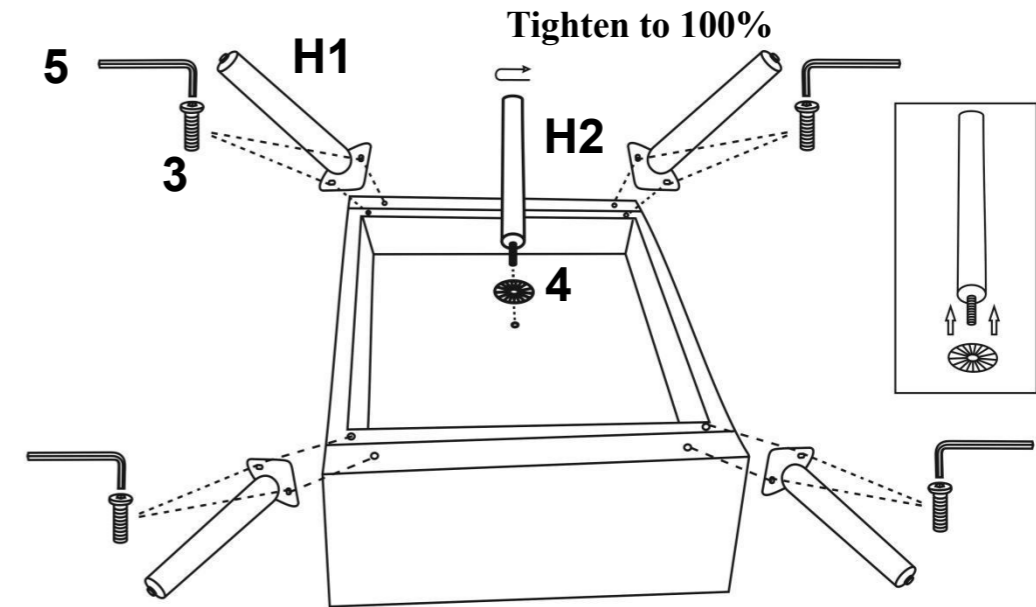

## DIAGRAM 3 (Assemble the Back Cushion)

Insert the Back Cushion(Part A) into the installed frame as shown in the picture.

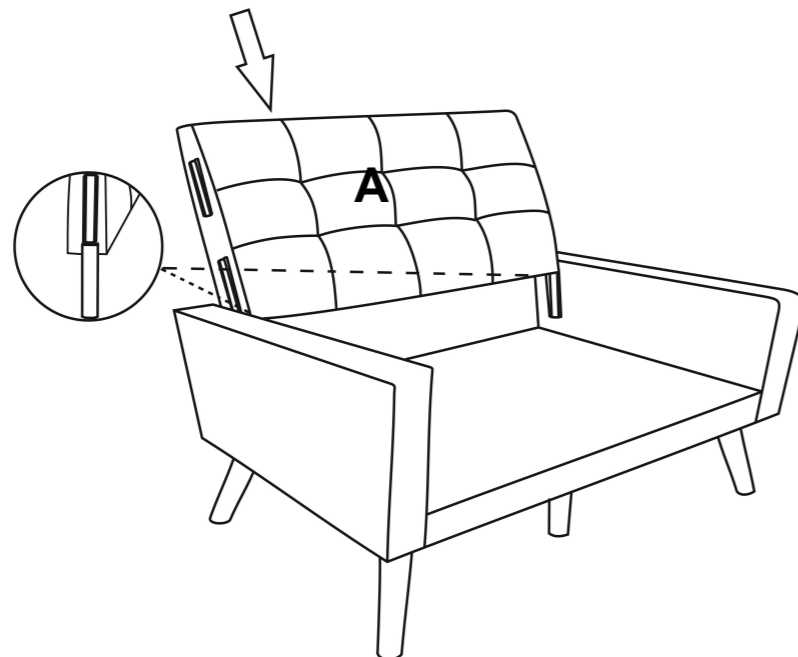

## DIAGRAM 4 (Assemble the Back Side and Seat Cushion)

Open the compressed packages.

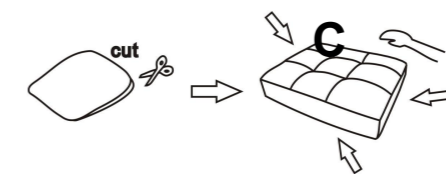

Insert the Back Side (Part F and G) into the Back Cushion and then put the Seat Cushion (Part C) on the chair

