

# NOTICE DE MONTAGE / ASSEMBLY INSTRUCTIONS

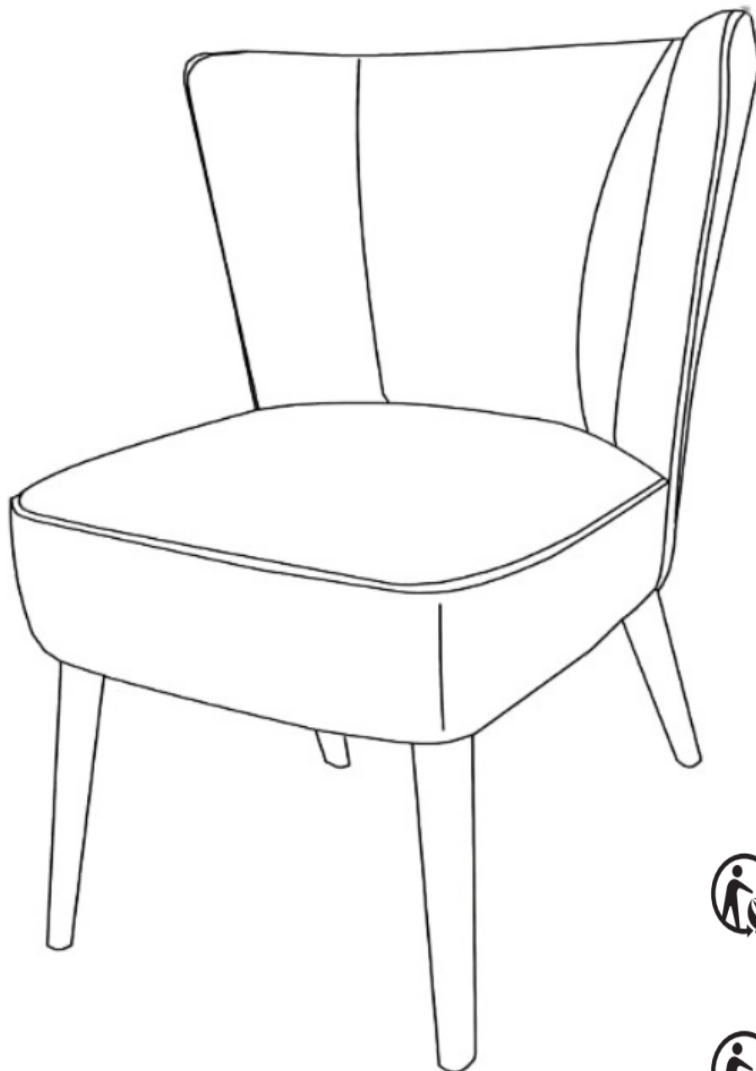

Séparez les éléments avant de trier



<https://quefairedemesdechets.fr>



FR

1. Repérez les différentes pièces nécessaires à l'assemblage de votre meuble.
  2. Regroupez et comptez les pièces de quincaillerie.
  3. Munissez-vous de l'outillage nécessaire à l'assemblage de votre meuble.
  4. Aménagez-vous un espace propice à l'assemblage; moquette et couverture peuvent protéger votre meuble des rayures
  5. Procédez au montage sans forcer. Il est recommandé de resserrer les vis au fil de l'utilisation.
  6. Après assemblage de ce produit, il est conseillé d'aérer régulièrement la pièce pendant quelques jours.
- CONSERVEZ VOTRE NOTICE DE MONTAGE. SI UNE PIÈCE VENAIT À MANQUER, L'INFORMATION RELATIVE À CELLE-CI FOURNIE PAR LA NOTICE DE MONTAGE RESTE LE MOYEN LE PLUS EFFICACE DE COMMUNIQUER AVEC VOTRE MAGASIN.**



EN

1. Identify the parts which make up your piece of furniture.
  2. Gather the hardware parts and count them.
  3. Have the necessary assembly tools ready.
  4. Organize a space for assembly, wall carpeting or a blanket will protect the furniture against scratches.
  5. Never force the assembling while you put the parts together. You are recommended to tighten the screws after the furniture has been used for some time.
  6. After assembling this product, it is advisable to regularly ventilate the room for a few days.
- KEEP THE ASSEMBLY INSTRUCTION. THE RELEVANT INFORMATION YOU CAN FIND ON IT WILL HELP YOU GET IN TOUCH WITH YOUR STORE IF A PART WAS TO BE MISSING.**

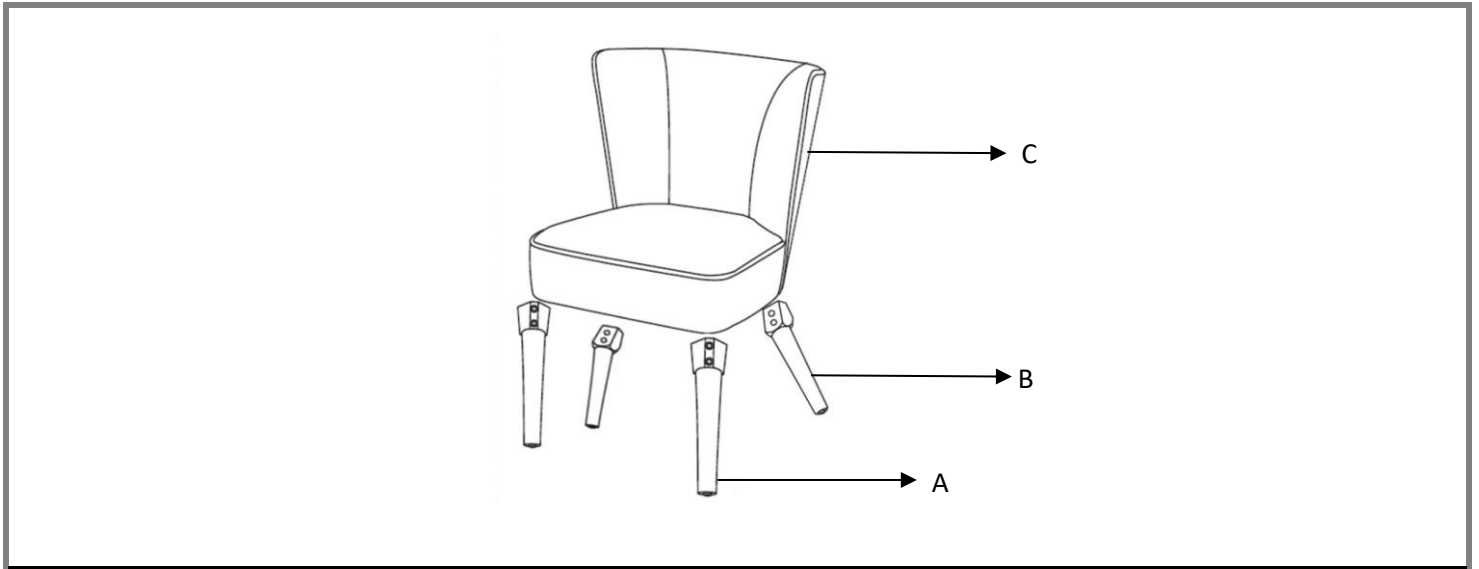



No-	Taille	Qté	Ctn no-
No-	Size	Qty	Ctn no-
No-	Tamaño	Cant	Ctn no-
Nr-	Maße	Anzahl	Ktn nr-
A	ø30/50mm*H337mm	2	1
B	ø30/50mm*H322mm	2	1
C	W550*D610*H480mm	1	1

No-	Taille	Qté	Ctn no-
No-	Size	Qty	Ctn no-
No-	Tamaño	Cant	Ctn no-
Nr-	Maße	Anzahl	Ktn nr-

No-	Taille	Qté	Ctn no-
No-	Size	Qty	Ctn no-
No-	Tamaño	Cant	Ctn no-
Nr-	Maße	Anzahl	Ktn nr-

Quincailleries/Hardware/Herrajes/ Montageteile-Ctn no-/Kto-nr- 1

D	x 8
	
M8*70mm	



E	x 8
	
M8*1.8mm	

F	x 8
	
M8*2.5mm	

G	x 1
	
M8*80mm	

H	x 4
	
Ø20*3mm	

 **TEMPS DE MONTAGE: 20 MINUTES**  
**SET-UP TIME: 20 MINUTES**

 **OUTILLAGE:**  
**TOOLS:** 

 **NOMBRE DE PERSONNES: 01**  
**NUMBER OF PERSONS: 01**



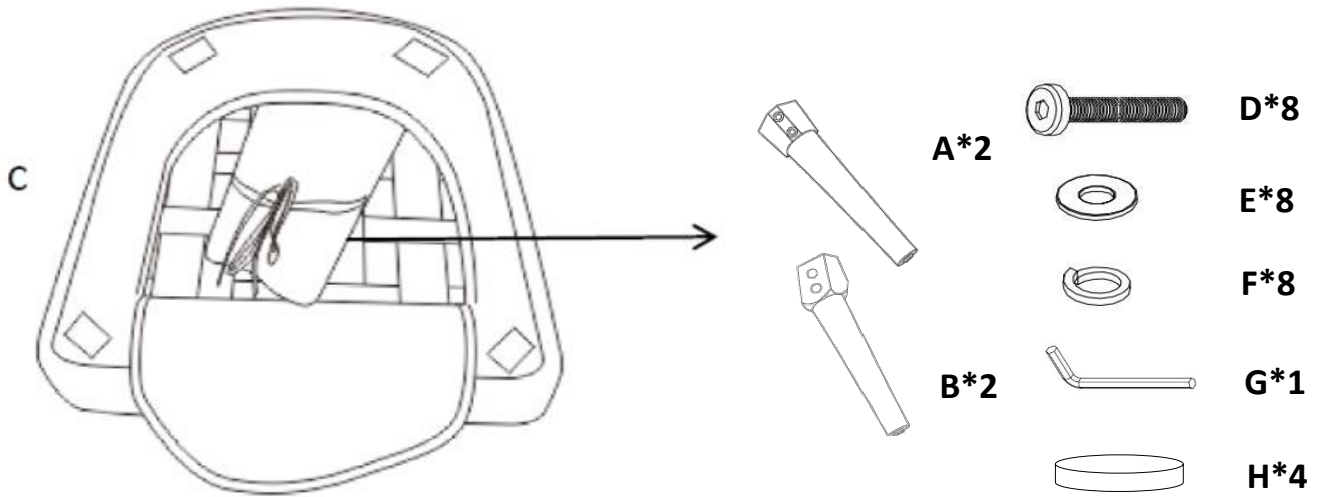

 **POUR L' ENTRETIEN, UN CHIFFON DOUX SUFFIRA-**  
**A SOFT CLOTH IS SUITABLE FOR PRODUCT CARE-**

1

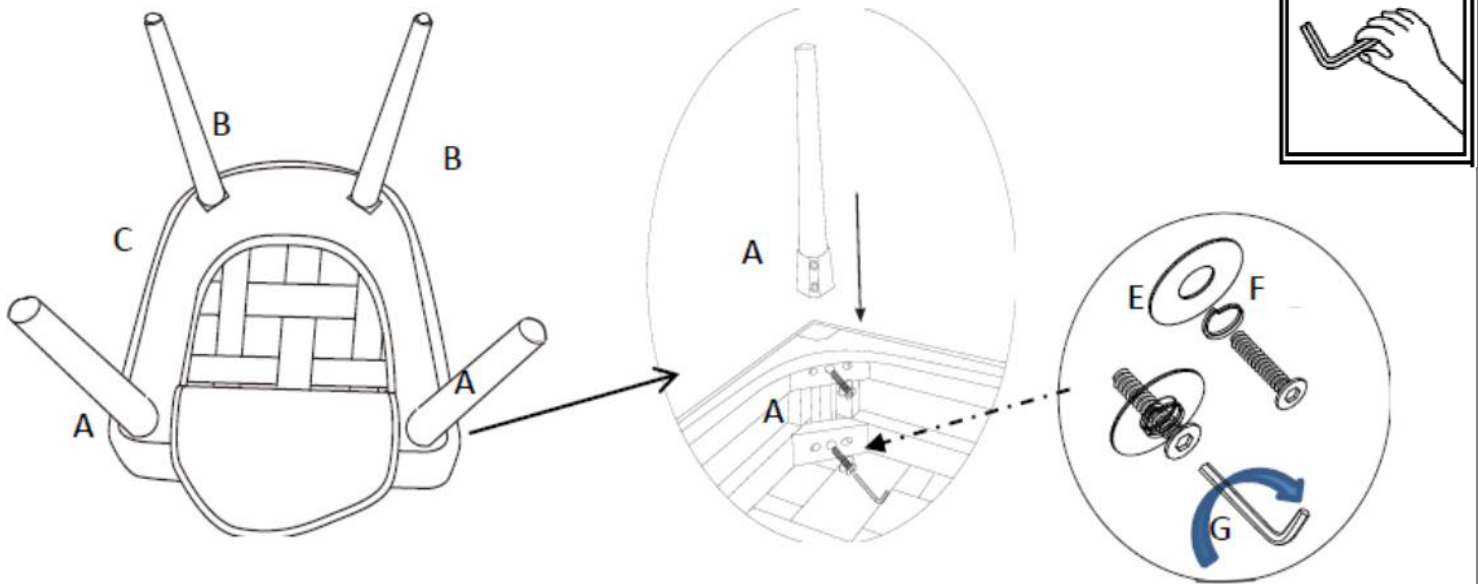



2

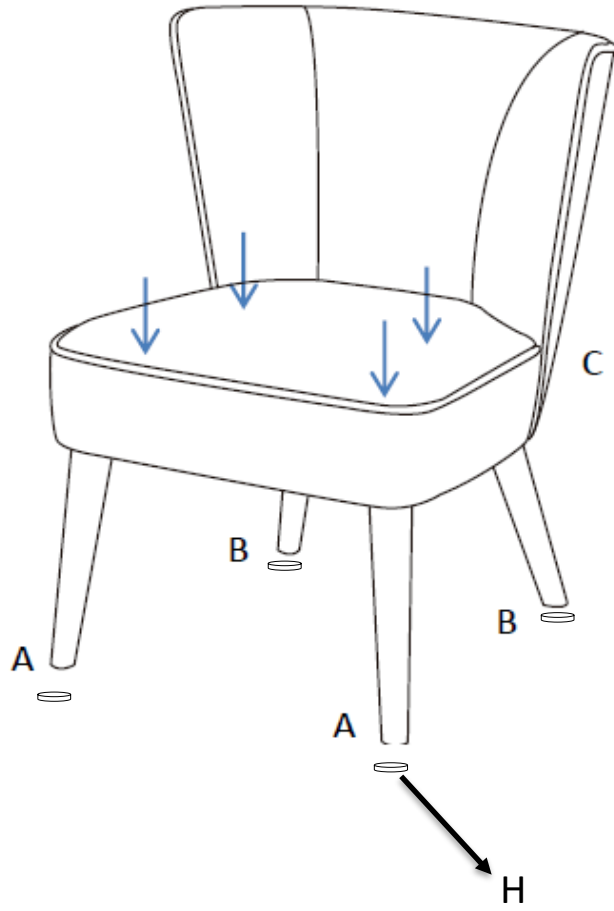
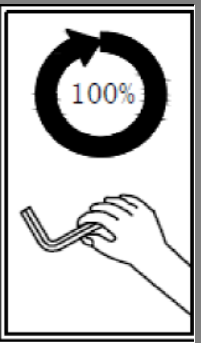

D	x 8	E	x 8	F	x 8	G	x 1
							
M8*70mm		M8*1.8mm		M8*2.5mm		M8*80mm	

3



H	x 4
	
Φ20*3mm	