

Conforama

CIRA PERGOLA

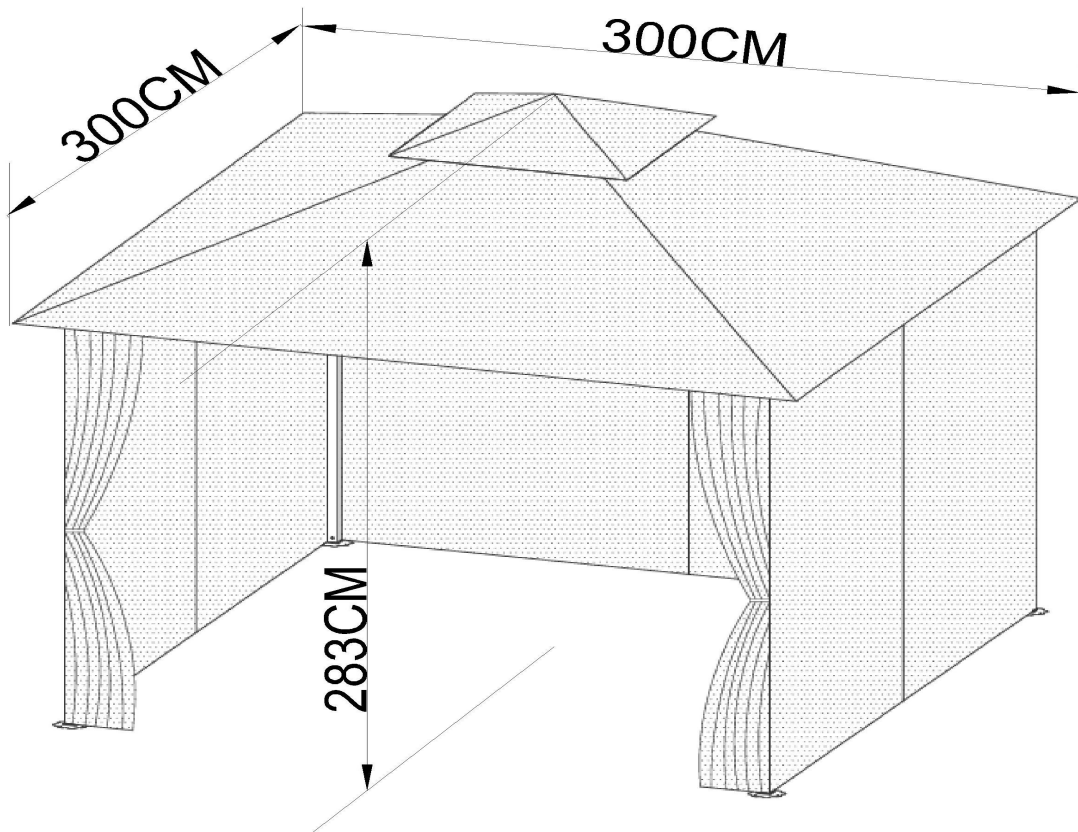

| | |
|-------------------|--------|
| CONFORAMA CODE(S) | 121794 |
|-------------------|--------|

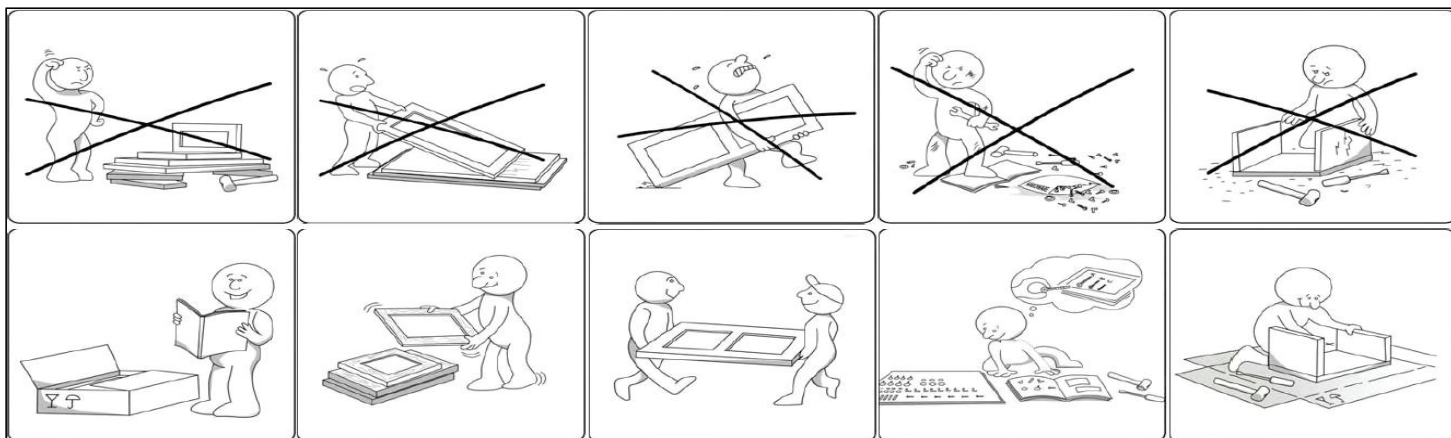

ES

INFORMACION DE SEGURIDAD

IMPORTANTE LEA ATENTAMENTE Y CONSÉRVELO PARA FUTURAS CONSULTAS

Este mueble es para uso doméstico.

Para uso en exteriores.

Se requiere montaje.

Compruebe que dispone de toda la tornillería y de todas las piezas antes de comenzar el montaje.

No monte ni utilice el mueble si hubiera piezas rotas o dañadas o si faltaran piezas, y emplee únicamente piezas aprobadas por el fabricante.

Utilice únicamente las herramientas suministradas o recomendadas.

Apriete firmemente las fijaciones empleando las herramientas suministradas o recomendadas.

El montaje, el apuntalamiento o la manipulación incorrectos podrían conducir al debilitamiento del ensamblado o de las piezas.

Mantenga a los niños alejados durante el montaje. El producto contiene piezas pequeñas que podrían ingerirse.

Todas las uniones deberán apretarse adecuadamente y verificarse periódicamente, volviéndolas a apretar si fuera necesario.

PT

INFORMACAO DE SEGURANCA

IMPORTANTE! LER ATENTAMENTE E GUARDAR PARA REFERÊNCIA FUTURA

Este mobiliário destina-se apenas a uso doméstico.

Para uso no exterior.

Mobiliário a ser montado pelo utilizador.

Certifique-se de que possui todas as ferragens e peças em bom estado antes de iniciar a montagem.

Não monte nem use o mobiliário se tiver peças partidas, danificadas ou em falta, e use apenas peças aprovadas pelo fabricante.

Use apenas ferramentas fornecidas ou recomendadas.

Aperte bem os fixadores usando as ferramentas fornecidas ou recomendadas.

Uma montagem, suporte ou manuseamento incorretos pode dar origem a um enfraquecimento da montagem e/ou das peças.

Mantenha as crianças pequenas afastadas durante a montagem. O produto contém peças pequenas suscetíveis de serem engolidas.



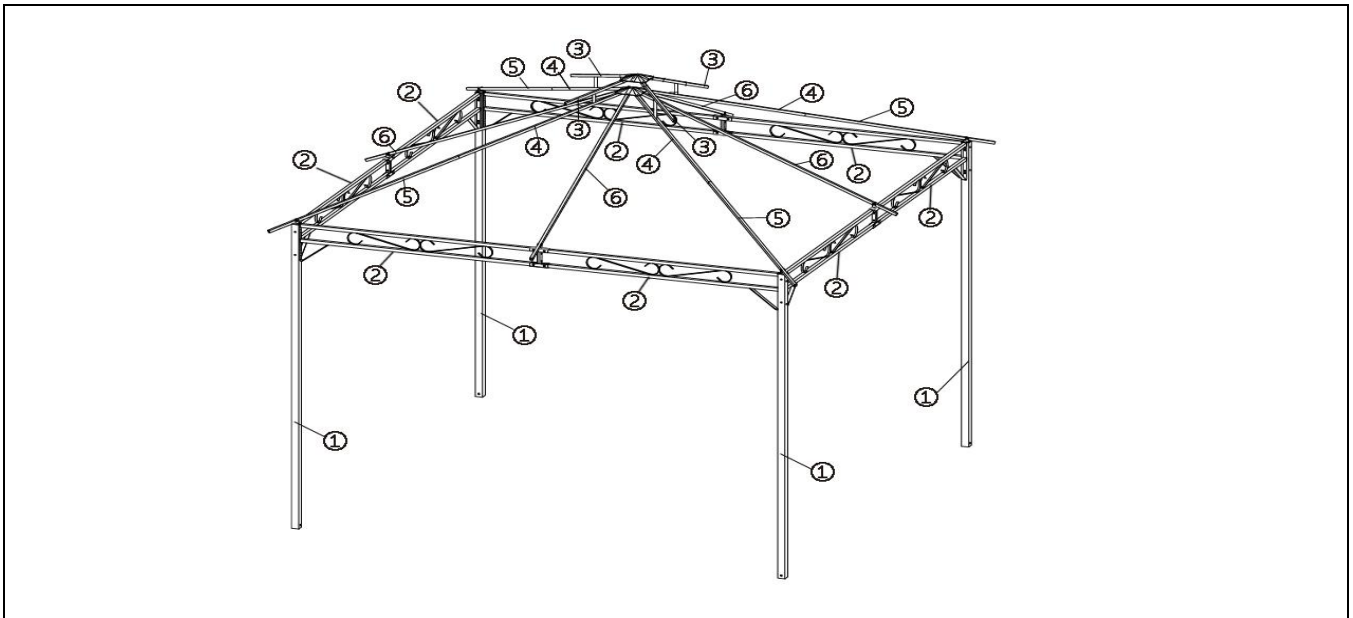













Todas as juntas deverão ser devidamente apertadas e verificadas regularmente, e apertadas novamente, se necessário.



| | | | | | |
|---|-----------------------------|---|----------|---|-----------|
|  | NO INCLUIDO NÃO INCLUIDO |  | 4 |  | 20 MIN |
|---|-----------------------------|---|----------|---|-----------|

| | | | | | | | | | | | | | | | |
|-----|-------------|-------|-----|---|------------|----|---|---|--|--|--|---|--|--|--|
| Nr. | ABMESSUNGEN | Menge | KTN | ⑤ | 15X15X1130 | X4 | 1 | ⑩ | | | | ⑮ | | | |
| ① | 40X40X2050 | x 4 | 1 | ⑥ | 15X15X1580 | X4 | 1 | ⑪ | | | | ⑯ | | | |
| ② | 250X20X1320 | X8 | 1 | ⑦ | | | | ⑫ | | | | | | | |
| ③ | 15X15X520 | X4 | 1 | ⑧ | | | | ⑬ | | | | | | | |
| ④ | 15X15X970 | X4 | 1 | ⑨ | | | | ⑭ | | | | | | | |





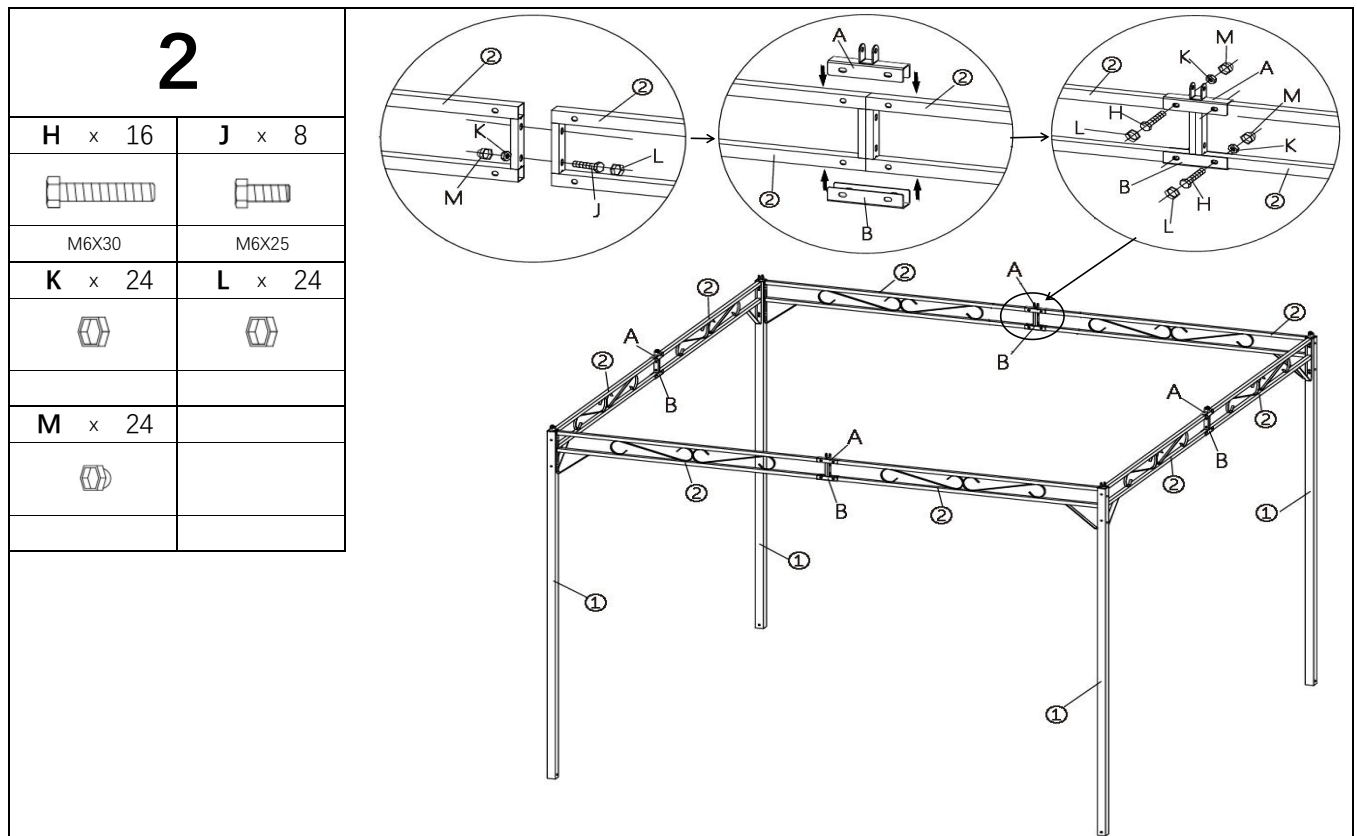
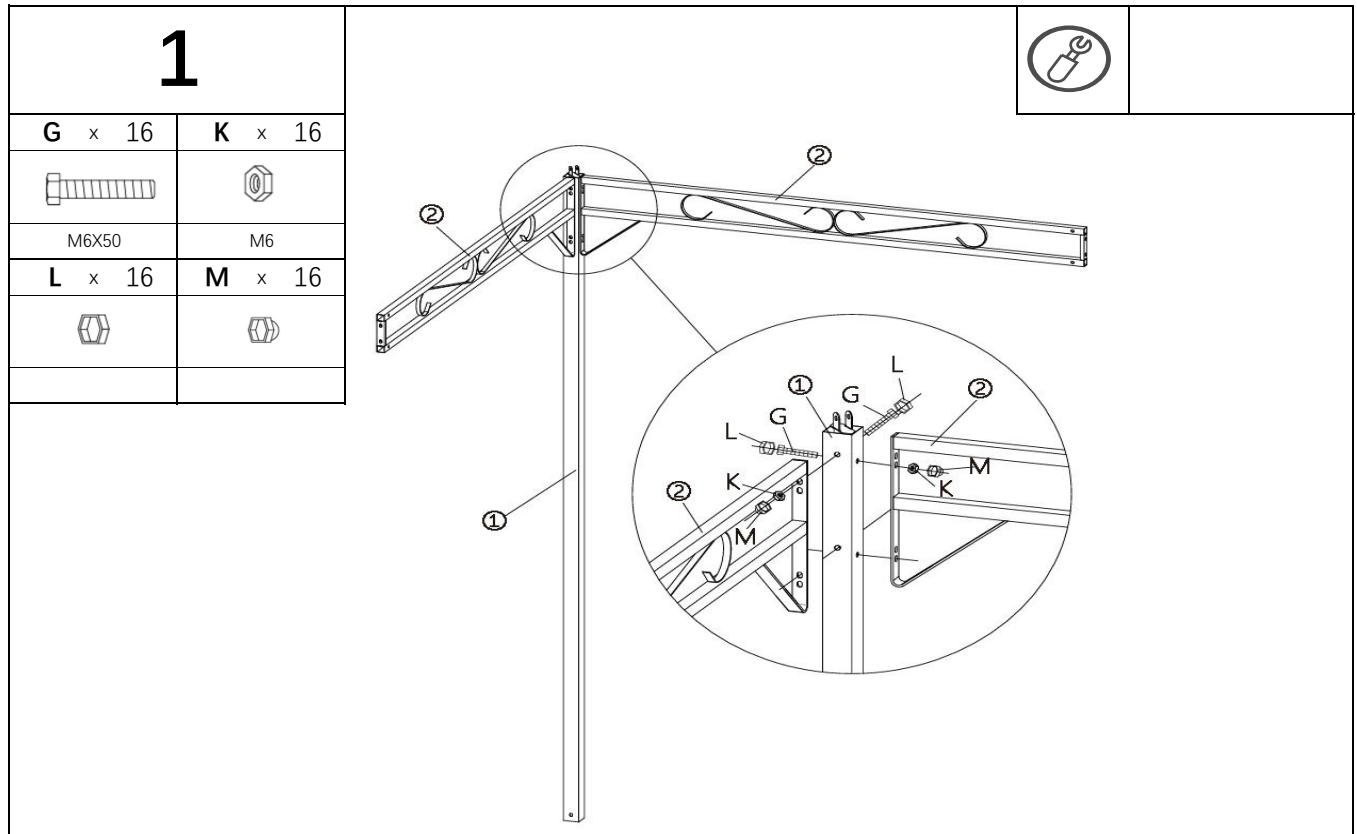

Herrajes / Hardware

| | | | | | | | |
|---|---|---|---|---|---|---|---|
| A x 4 | B x 4 | C x 2 | D x 4 | E x 4 | F x 8 | G x 20 | H x 16 |
|  |  |  |  |  |  |  |  |
| | | | | | | M6X50 | M6X30 |
| J x 36 | K x 72 | L x 52 | M x 52 | N x 2 | P x 8 | Q x 1 | R x 1 |
|  |  |  |  |  |  |  |  |
| M6x25mm | M6 | | | | | | |
| S x 4 | | | | | | | |
|  | | | | | | | |





3

| | |
|---|---|
| A x 4 | J x 16 |
|  |  |
| | M6X25 |
| K x 16 | L x 8 |
|  |  |
| M x 8 | C x 1 |
|  |  |

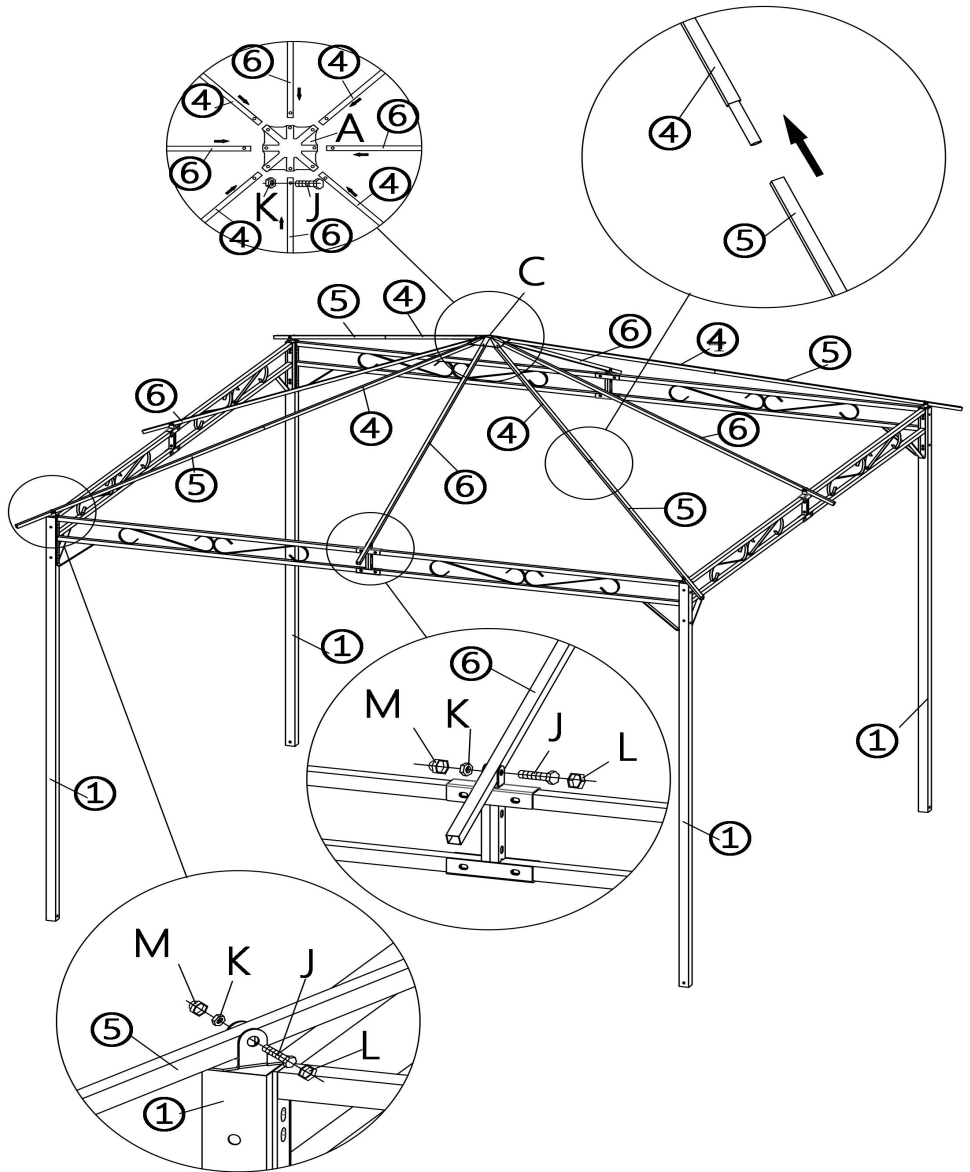

4

C x 1



D x 4



J x 12



M6x25mm





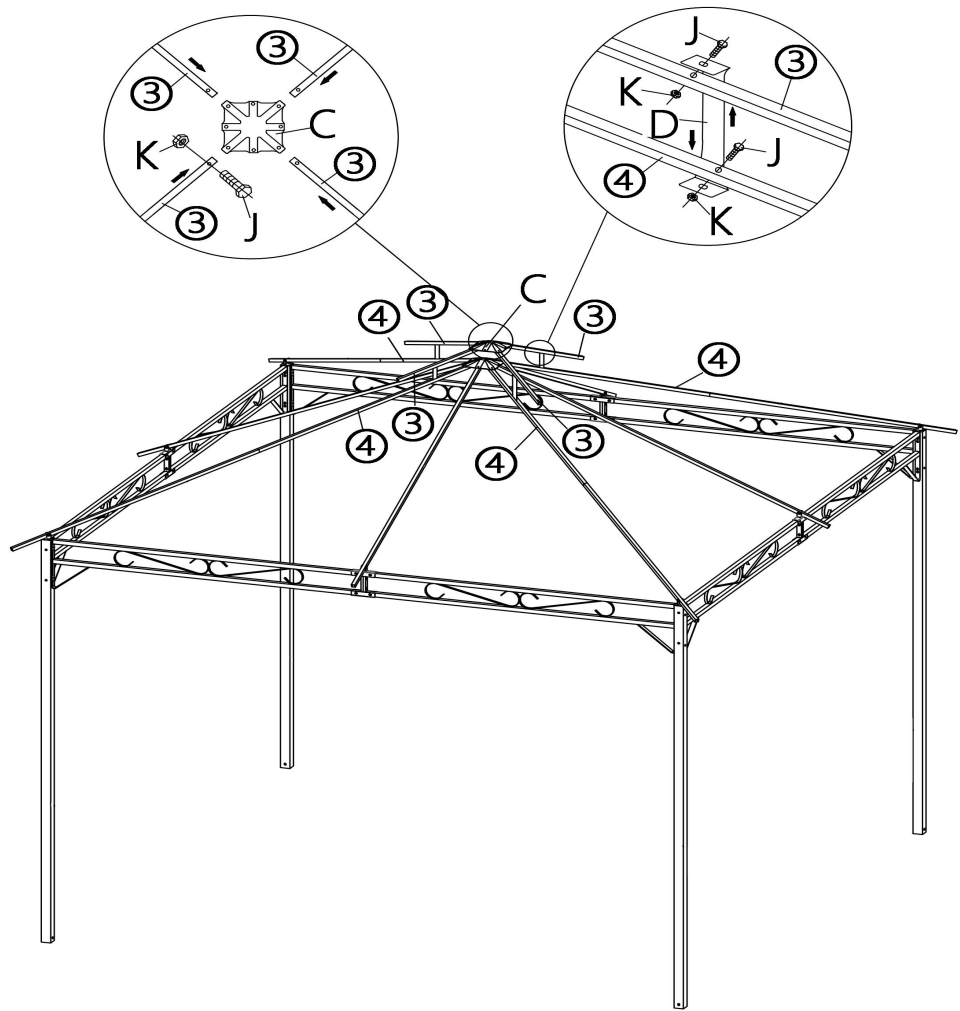

K x 12



M6



5

| | |
|---|---|
| E x 4 | F x 8 |
|  |  |
| G x 4 | K x 4 |
|  |  |
| M6X50 | M6 |
| L x 4 | M x 4 |
|  |  |

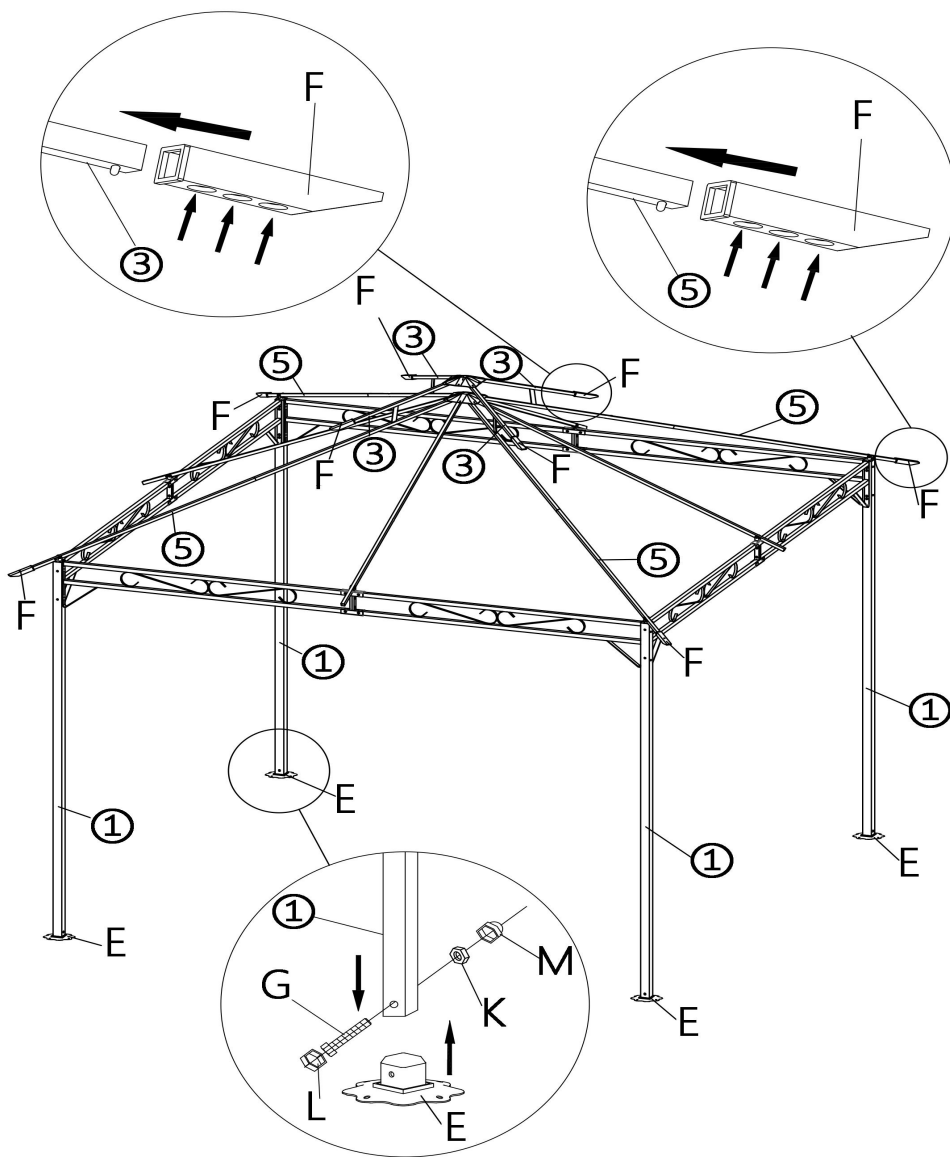

6

R x 1

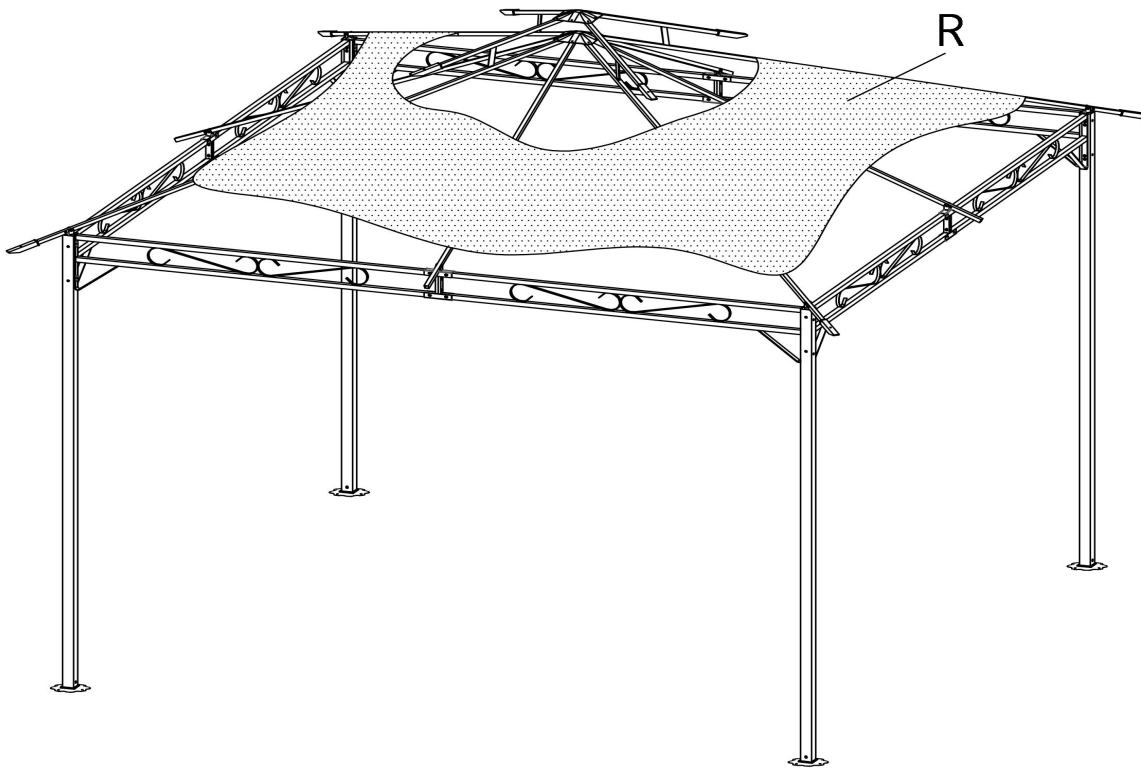
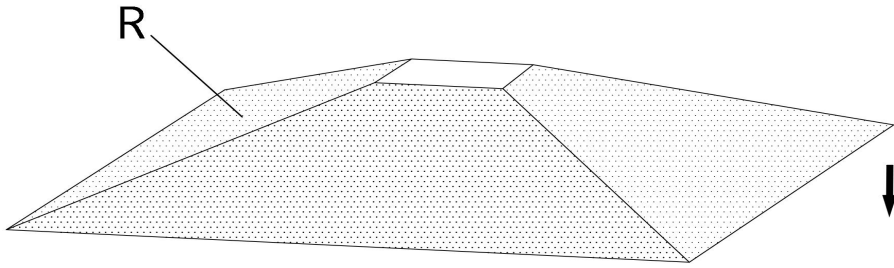

7

Q x 1

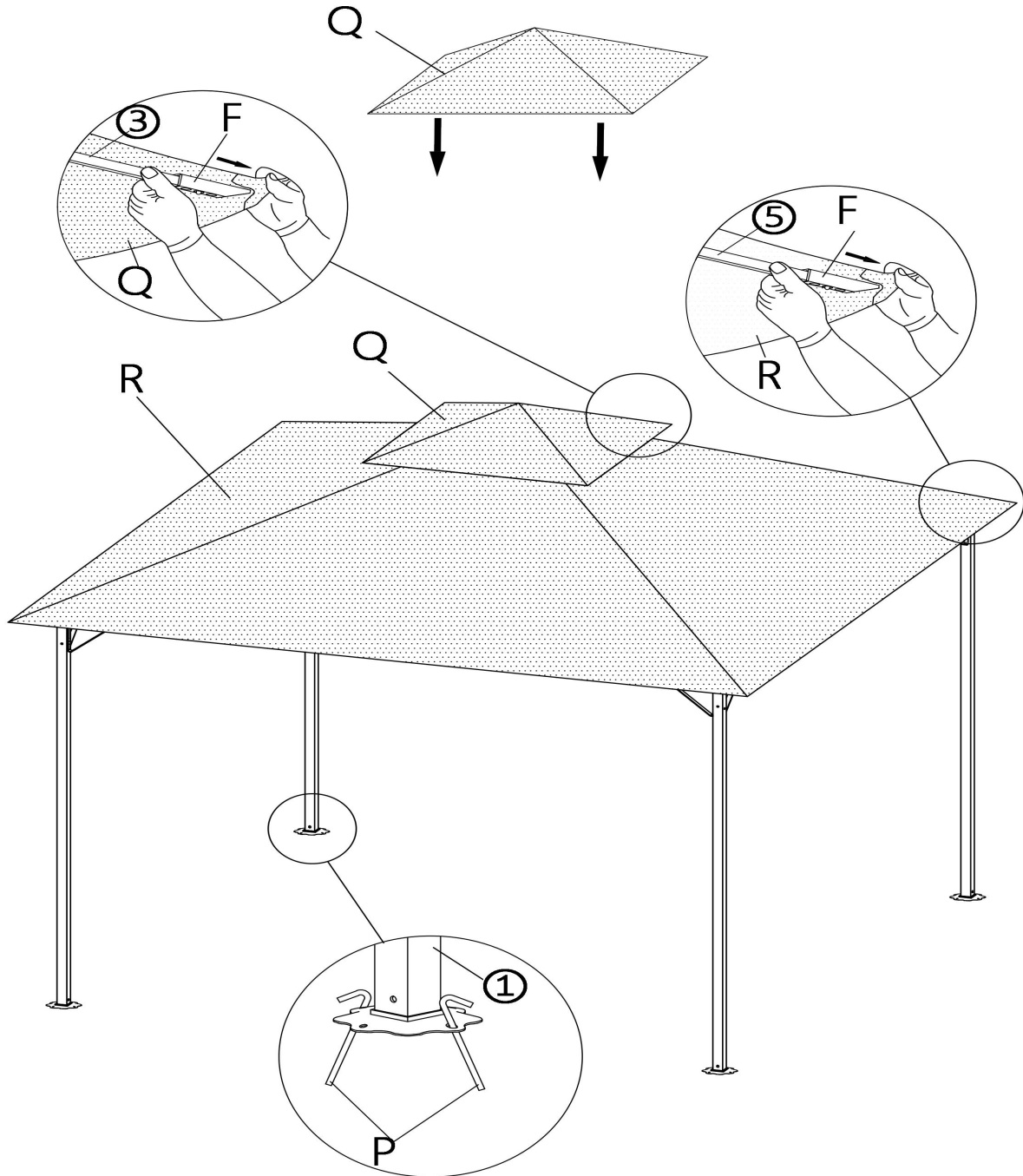

8

S x 4

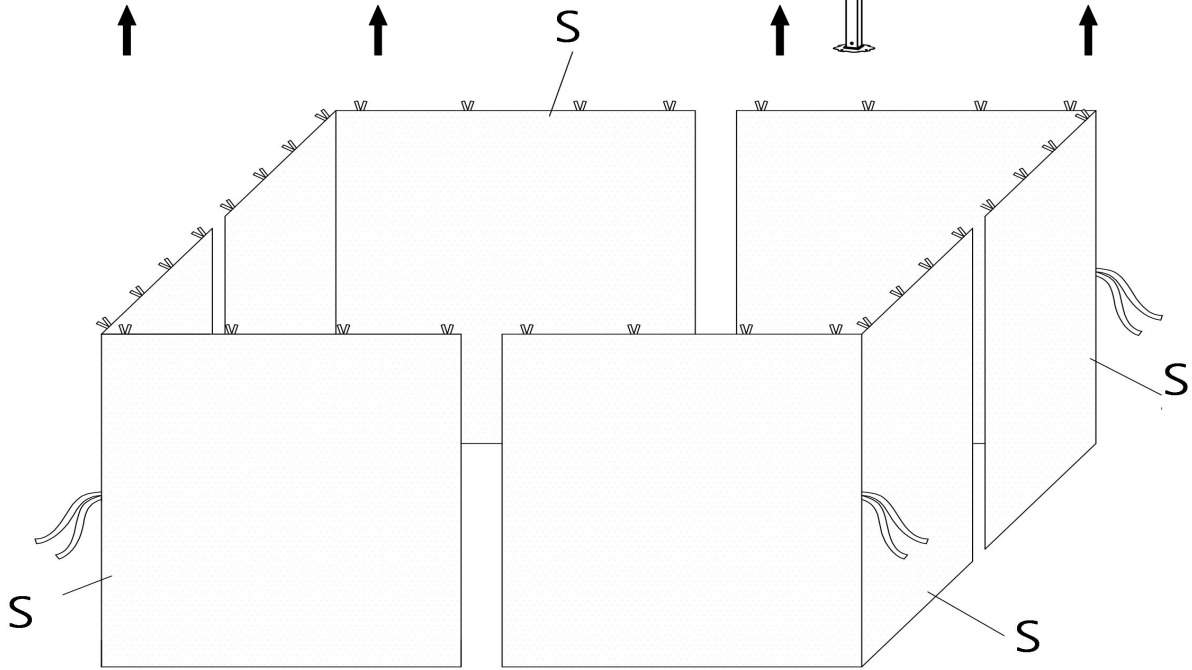
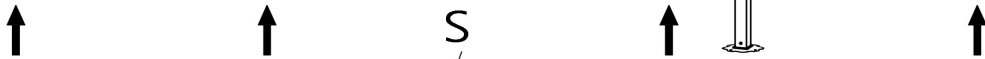
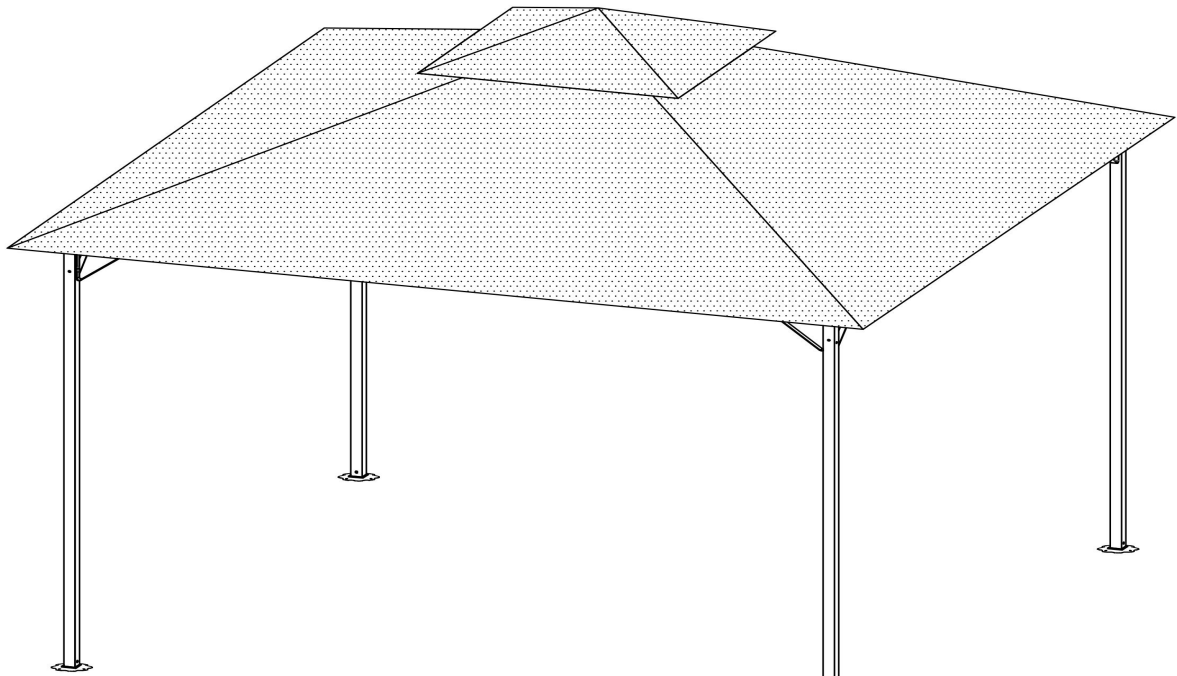

ES

| | |
|---------------------------------|---|
| INSTRUCCIONES DE USO | No fuerce nunca las conexiones. Vuelva a apretar los tornillos al cabo de unos días. Conserve el folleto de instrucciones. Este contiene información para pedir repuestos. |
|---------------------------------|---|

| | |
|---|---|
| ALMACENAMIENT OY MANTENIMIENTO | El mobiliario de exteriores puede limpiarse con agua y jabón. Si el acero no fuera inoxidable, límpielo minuciosamente para evitar el óxido. Guarde siempre el producto seco y limpio a temperatura ambiente. |
|---|---|

PT

| | |
|-------------------------------------|--|
| INSTRUÇÕES DE UTILIZAÇÃO | Nunca force as ligações. Volte a apertar os parafusos passados alguns dias. Guarde o folheto das instruções. Este contém informação para quando precisar de pedir peças em falta. |
|-------------------------------------|--|

| | |
|---------------------------------------|--|
| ARMAZENAMENTO E MANUTENÇÃO | Mobiliário de exterior pode ser limpo com sabão e água. Se o aço não for inoxidável, limpe-o cuidadosamente para evitar ferrugem. Guarde sempre o produto limpo e seco à temperatura ambiente. |
|---------------------------------------|--|